

SAMSUNG

Quick Start Manual

Guide de prise en main rapide

PL70



For more information, refer to the User Manual included on the supplied **CD-ROM**.

Pour des instructions plus détaillées, veuillez consulter le mode d'emploi complet sur le **CD-ROM** fourni avec l'appareil.

This Quick Start Manual has been specially designed to guide you through the basic functions and features of your device. Please read the Quick Start Manual and User Manual carefully to ensure safe and correct use.

Ce guide de prise en main rapide a été spécialement conçu pour vous permettre de découvrir les fonctions et caractéristiques de base de votre appareil. Afin de garantir une utilisation sûre et correcte, lisez attentivement le guide de prise en main rapide et le mode d'emploi.

ENG / SPA / FRE

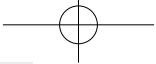

Contents



Health and safety information.....	2	1
Camera layout	4	12
Setting up your camera	5	
Unpacking	5	11
Inserting the battery and memory card	6	
Charging the battery	6	
Turning on your camera.....	7	
Selecting options	7	16
Capturing photos or videos	8	25
Playing files	9	51
Transferring files to a PC (Windows)	10	65
Specifications	11	87

Health and safety information

Warnings

Do not use your camera near flammable or explosive gases and liquids

Do not use your camera near fuels, combustibles, or flammable chemicals. Do not store or carry flammable liquids, gases, or explosive materials in the same compartment as the camera or its accessories.

Keep your camera away from small children and pets

Keep your camera and all accessories out of the reach of small children and animals. Small parts may cause choking or serious injury if swallowed. Moving parts and accessories may present physical dangers as well.

Prevent damage to subjects' eyesight

Do not use the flash in close proximity (closer than 1m/3 ft) to people or animals. Using the flash too close to your subject's eyes can cause temporary or permanent damage.

Handle and dispose of batteries and chargers with care

- Use only Samsung-approved batteries and chargers. Incompatible batteries and chargers can cause serious injuries or damage to your camera.
- Never place batteries or cameras on or in heating devices, such as microwave ovens, stoves, or radiators. Batteries may explode when overheated.

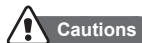

Handle and store your camera carefully and sensibly

- Do not allow your camera to get wet—liquids can cause serious damage. Do not handle your camera with wet hands. Water damage to your camera can void your manufacturer's warranty.
- Avoid using or storing your camera in dusty, dirty, humid, or poorly-ventilated areas to prevent damage to moving parts and internal components.

- Exercise caution when connecting cables or adapters and installing batteries and memory cards. Forcing the connectors, improperly connecting cables, or improperly installing batteries and memory cards can damage ports, connectors, and accessories.
- Do not insert foreign objects into any of your camera's compartments, slots, or access points. This type of damage may not be covered by your warranty.

Protect batteries, chargers, and memory cards from damage

- Avoid exposing batteries or memory cards to very cold or very hot temperatures (below 0° C/32° F or above 40° C/104° F). Extreme temperatures can reduce the charging capacity of your batteries and can cause memory cards to malfunction.
- Prevent memory cards from making contact with liquids, dirt, or foreign substances. If dirty, wipe the memory card clean with a soft cloth before inserting in your camera.

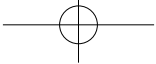

Camera layout

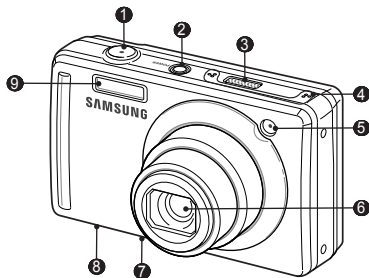

- ① Shutter button
- ② POWER button
- ③ Speaker
- ④ Microphone
- ⑤ AF-assist light/timer lamp
- ⑥ Lens
- ⑦ USB, A/V, and HDMI port
- ⑧ Battery chamber cover
- ⑨ Flash

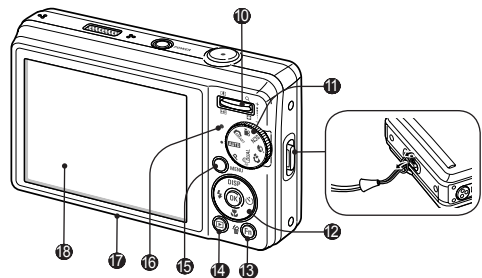

- ⑩ Zoom button
- ⑪ Mode dial
- ⑫ Navigation button/OK button
- ⑬ Function button
- ⑭ Playback button
- ⑮ MENU button
- ⑯ Status lamp
- ⑰ Tripod mount
- ⑱ Display

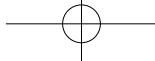

Setting up your camera

Unpacking



Camera



AC adapter/USB cable



Rechargeable battery



Strap

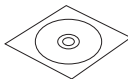

Software CD-ROM
(User manual included)



Quick Start Manual

Optional accessories



Camera case



Memory cards



A/V cable

Sold as a set

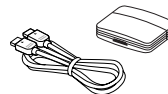

HDMI cable/HDMI adapter

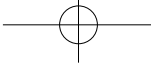

Setting up your camera

Inserting the battery and memory card

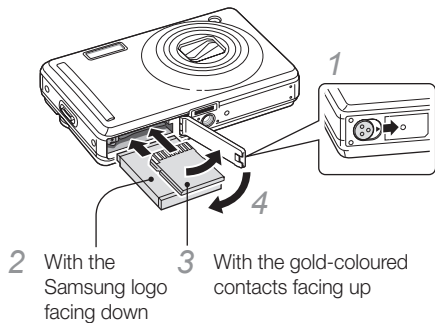

▼ Removing the battery

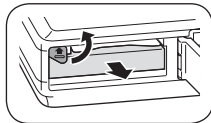

▼ Removing the memory card

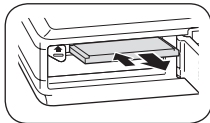

Push gently until the card disengages from the camera and then pull it out of the slot.

6

Charging the battery

Before using the camera for the first time, you must charge the battery.

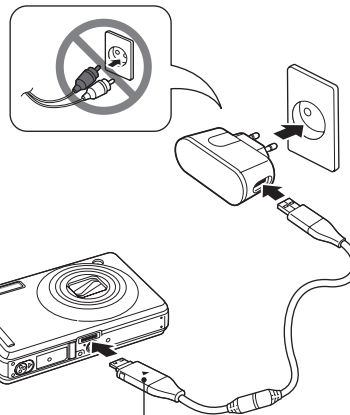

Indicator light

- Red: Charging
- Green: Fully charged

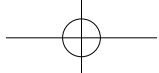

Turning on your camera

- 1 Press **[POWER]**.
 - The initial setup screen appears.

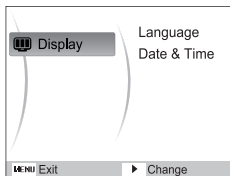

- 2 Press **[\odot]** to select **Language** and press **[\odot]**.
- 3 Press **[DISP]** or **[\downarrow]** to select a language and press **[OK]**.
- 4 Press **[DISP]** or **[\downarrow]** to select **Date & Time** and press **[\odot]**.
- 5 Press **[\leftarrow]** or **[\odot]** to select an item.
- 6 Press **[DISP]** or **[\downarrow]** to change the number or select another date format and press **[OK]**.

Selecting options

- 1 In Shooting mode, press **[MENU]**.
- 2 Use the navigation buttons to scroll to an option or menu.

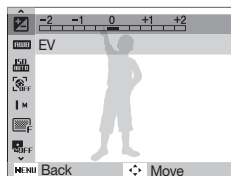

- 2
 - To move left or right, press **[\leftarrow]** or **[\odot]**.
 - To move up or down, press **[DISP]** or **[\downarrow]**.
- 3 Press **[OK]** to confirm the highlighted option or menu.
 - Press **[MENU]** again to go back to the previous menu.

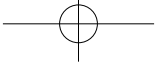

Capturing photos or videos

Taking a photo

- 1 Rotate the mode dial to **AUTO**.
- 2 Align your subject in the frame.
- 3 Press **[Shutter]** halfway down to focus automatically.
 - A green frame means the subject in focus.

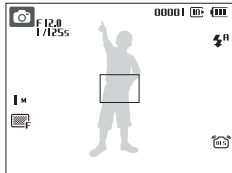

- 4 Press **[Shutter]** all the way down to take the photo.

Recording a video

- 1 Rotate the mode dial to **[Video]**.
- 2 Align your subject in the frame.
- 3 Press **[Shutter]**.
 - Press **[OK]** to pause or resume.
- 4 Press **[Shutter]** again to stop the recording.

Note

Number of photos by resolution (for 1 GB SD)

	Resolution	Super fine	Fine	Normal
12M	4000 X 3000	142	274	389
10M	3984 X 2656	162	302	426
9M	3968 X 2232	195	355	509
8M	3264 X 2448	204	361	518
5M	2592 X 1944	327	547	764
3M	2048 X 1536	511	774	1,028
2M	1920 X 1080	737	1,104	1,387
1M	1024 X 768	1,290	1,612	1,807

These figures are measured under Samsung's standard conditions and may vary depending on shooting conditions and camera settings.

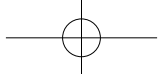

Playing files

Viewing photos

- 1 Press [▶].
- 2 Press [⚡] or [⌚] to scroll through files.
 - Press and hold to view files quickly.

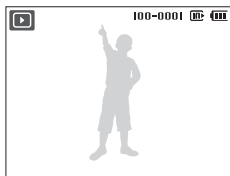

Viewing videos

- 1 Press [▶].
- 2 Press [OK].

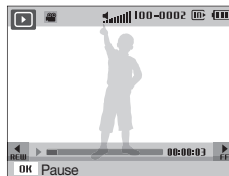

- 3 Use the following buttons to control playback.

[⚡]	Scan backward
[OK]	Pause or resume playback
[⌚]	Scan forward
[Zoom] up or down	Adjust the volume level

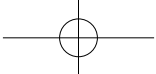

Transferring files to a PC (Windows)

- 1 Insert the installation CD in a CD-ROM drive and follow the onscreen instructions.
- 2 Connect the camera to the PC with the USB cable.

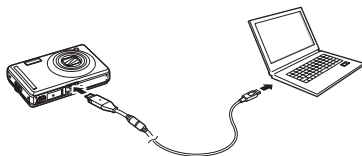

- 3 Turn on the camera.
- 4 On your PC, select **My Computer** → **Removable Disk** → **DCIM** → **100PHOTO**.
- 5 Select the files you want and drag or save them to the PC.

Disconnecting safely (for Windows XP)



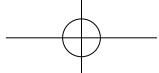

Specifications

Image sensor	<ul style="list-style-type: none">Type: 1/2.3" (approx. 7.79 mm) CCDEffective pixels: approx. 12.2 mega-pixelsTotal pixels: approx. 12.4 mega-pixels
Lens	<ul style="list-style-type: none">Focal length: Samsung lens f = 5 - 25 mm (35 mm film equivalent: 28 - 140 mm)F-stop range: F3.4 (W) - F5.8 (T)
Display	3.0" (7.62 cm) 230 K, TFT LCD
Focusing	TTL auto focus (Multi AF, Center AF)
Shutter speed	<ul style="list-style-type: none">Auto: 1/8 - 1/2,000 sec.Program: 1 - 1/2,000 sec. (AEB, Continuous: 1/4 - 1/2,000 sec.)Night: 8 - 1/2,000 sec.Firework: 2 sec.
Storage	<ul style="list-style-type: none">Internal memory: approx. 76 MBExternal memory (Optional): SD card (up to 4 GB guaranteed), SDHC card (up to 8 GB guaranteed), MMC Plus (up to 2 GB guaranteed) <p>Internal memory capacity may not match these specifications.</p>
DC power input connector	34 pin
Rechargeable battery	Lithium-ion battery (SLB-10A, 1,050 mAh)
Dimensions (W x H x D)	95.8 x 59.5 x 23.9 mm
Weight	149 g (without battery and memory card)
Operating temperature	0 - 40° C
Operating humidity	5 - 85 %

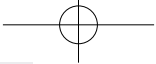

Contenido

Información sobre salud y seguridad	2	1
Diseño de la cámara	4	12
Configuración de la cámara	5	
Desembalaje	5	11
Insertar la batería y la tarjeta de memoria	6	
Cargar la batería.....	6	
Encender la cámara	7	
Selección de opciones	7	16
Captura de fotografías o vídeos.....	8	25
Reproducción de archivos ...	9	51
Transferencia de archivos a un ordenador (para Windows) ...	10	65
Especificaciones	11	87



Información sobre salud y seguridad



Advertencias

No utilice la cámara cerca de líquidos y gases explosivos o inflamables

No utilice la cámara cerca de carburantes, combustibles o sustancias químicas inflamables. No almacene ni transporte líquidos inflamables, gases o materiales explosivos en el mismo compartimento en el que están la cámara o los accesorios.

Mantenga la cámara alejada del alcance de los niños y las mascotas

Mantenga la cámara y todos los accesorios fuera del alcance de los niños y los animales. Es posible que se traguen las piezas más pequeñas y, como consecuencia, se asfixien o sufran graves lesiones. Los accesorios y las piezas móviles también pueden causar daños físicos.

Evite dañar la vista del sujeto

No utilice el flash si está a una proximidad inferior a 1m de las personas o los animales. Si utiliza el flash cuando está demasiado cerca de los ojos del sujeto, puede producirle daños temporales o permanentes.

ES-2

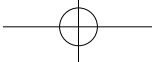

Utilice y deseche las baterías y los cargadores con cuidado

- Utilice únicamente baterías y cargadores aprobados por Samsung. Las baterías y los cargadores incompatibles pueden producirle graves lesiones o causar daños a la cámara.
- Nunca coloque las baterías o las cámaras dentro de dispositivos conductores de calor, como hornos de microondas, estufas o radiadores, ni sobre ellos. Las baterías pueden explotar si se recalientan.



Precauciones

Utilice y guarde la cámara con cuidado y de manera prudente

- No permita que la cámara se moje, ya que los líquidos pueden causarle graves daños. No manipule la cámara si tiene las manos mojadas. Si se producen daños en la cámara a causa del agua, se puede anular la garantía del fabricante.
- No utilice ni guarde la cámara en áreas en las que haya polvo, suciedad, humedad o poca ventilación, a fin de evitar daños en las partes móviles o en los componentes internos.

- Tenga cuidado al conectar los cables y los adaptadores y al instalar las baterías y las tarjetas de memoria. Si ejerce demasiada fuerza sobre los conectores, conecta de manera inapropiada los cables o instala de manera inadecuada las baterías y las tarjetas de memoria, puede dañar los puertos, los conectores y los accesorios.
- No inserte objetos extraños en ningún compartimento, ranura o punto de acceso de la cámara. Es posible que la garantía no cubra este tipo de daños.

Proteja las baterías, los cargadores y las tarjetas de memoria contra daños

- No exponga las baterías o las tarjetas de memoria a temperaturas demasiado bajas o demasiado altas (inferiores a 0 °C/32 °F o superiores a 40 °C/104 °F). Las temperaturas extremas pueden reducir la capacidad de carga de las baterías y generar un funcionamiento defectuoso de las tarjetas de memoria.
- Evite que las tarjetas de memoria entren en contacto con líquidos, suciedad o sustancias extrañas. Si la tarjeta de memoria se ensucia, límpiela con un paño suave antes de insertarla en la cámara.

ES-3

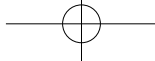

Diseño de la cámara

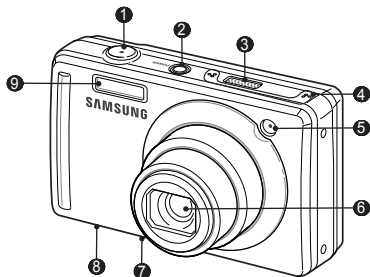

- 1 Botón del obturador
- 2 Botón de encendido y apagado
- 3 Altavoz
- 4 Micrófono
- 5 Luz AF auxiliary/luz de temporizador
- 6 Lente
- 7 Puerto USB, A/V y HDMI
- 8 Cubierta de la cámara de la batería
- 9 Flash

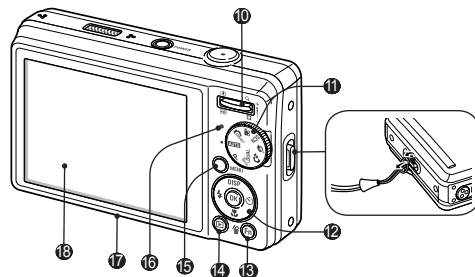

- 10 Botón de zoom
- 11 Selector de modos
- 12 Botón de navegación/botón OK
- 13 Botón de funciones
- 14 Botón de reproducción
- 15 Botón de menú
- 16 Luz indicadora de estado
- 17 Orificio para el montaje del trípode
- 18 Pantalla

ES-4

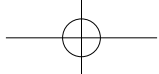

Configuración de la cámara

Desembalaje



Cámara



Fuente de alimentación/
Cable USB



Batería recargable



Correa

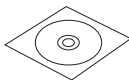

CD-ROM del software
(incluye el manual del usuario)



Manual de inicio rápido

Accesorios opcionales



Estuche para la cámara



Tarjetas de memoria



Cable A/V

En venta como kit

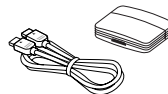

Cable HDMI/Adaptador HDMI

ES-5

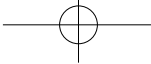

Configuración de la cámara

Insertar la batería y la tarjeta de memoria

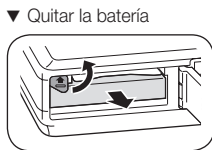
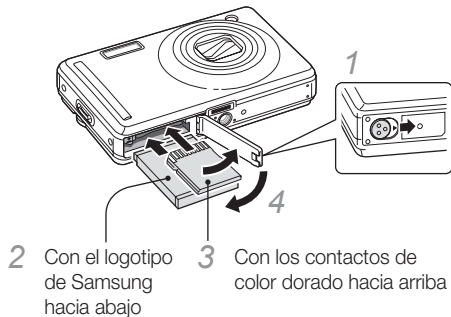

Ejerza una leve presión hasta que la tarjeta se desprenda de la cámara y, luego, retírela de la ranura.

Cargar la batería

Cargue la pila antes de utilizar la cámara.

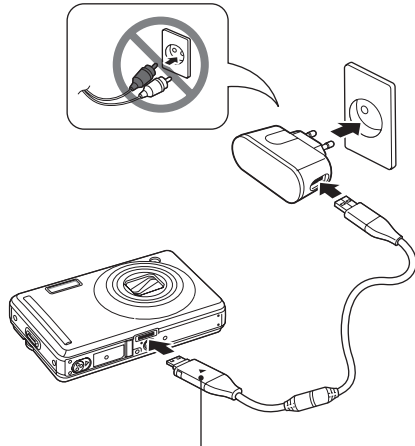

- Luz indicadora**
- Rojo: cargándose
 - Verde: completamente cargada

ES-6

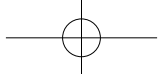

Encender la cámara

- 1 Pulse **[POWER]**.
 - Aparecerá la ventana de configuración inicial.

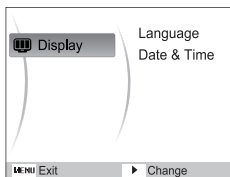

- 2 Pulse **[OK]** para seleccionar **Language** y pulse **[OK]**.
- 3 Pulse **[DISP]** o **[Mover]** para seleccionar un idioma y pulse **[OK]**.
- 4 Pulse **[DISP]** o **[Mover]** para seleccionar **Date & Time** y pulse **[OK]**.
- 5 Pulse **[DISP]** o **[Mover]** para seleccionar un elemento.
- 6 Pulse **[DISP]** o **[Mover]** para cambiar el número o seleccionar otro formato de fecha y pulse **[OK]**.

Selección de opciones

- 1 En el modo de disparo, pulse **[MENU]**.
- 2 Utilice los botones de navegación para desplazarse hacia una opción o hacia un menú.

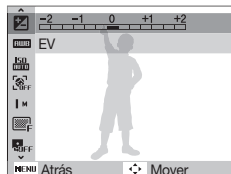

- 3 Pulse **[OK]** para confirmar la opción o el menú resaltados.
 - Pulse **[MENU]** nuevamente para regresar al menú anterior.

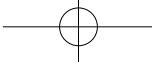

Captura de fotografías o vídeos

Tomar una fotografía

- 1 Gire el selector de modos hasta **AUTO**.
- 2 Alinee el sujeto en el marco.
- 3 Pulse [**Obturador**] hasta la mitad para utilizar el enfoque automático.
 - Si aparece un cuadro verde, significa que el sujeto está enfocado.

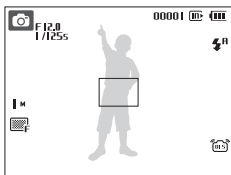

- 4 Pulse completamente [**Obturador**] para tomar la fotografía.

Grabar un vídeo

- 1 Gire el selector de modos hasta **📹**.
- 2 Alinee el sujeto en el marco.
- 3 Pulse [**Obturador**].
 - Pulse [**OK**] para pausar o reanudar.
- 4 Pulse [**Obturador**] nuevamente para detener la grabación.

Nota

Cantidad de fotografías por resolución (para SD de 1GB)

	Resolución	Superfina	Fina	Normal
12M	4000 x 3000	142	274	389
10M	3984 x 2656	162	302	426
9M	3968 x 2232	195	355	509
8M	3264 x 2448	204	361	518
5M	2592 x 1944	327	547	764
3M	2048 x 1536	511	774	1.028
2M	1920 x 1080	737	1.104	1.387
1M	1024 x 768	1.290	1.612	1.807

Estas son medidas tomadas en condiciones estándar, establecidas por Samsung, y pueden variar según las condiciones de disparo y la configuración de la cámara.

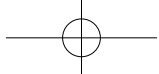

Reproducción de archivos

Ver fotografías

- 1 Pulse [▶].
- 2 Pulse [⚡] o [⌂] para desplazarse por los archivos.
 - Mantenga la tecla pulsada para ver los archivos rápidamente.

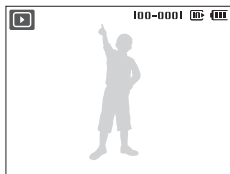

Ver videos

- 1 Pulse [▶].
- 2 Pulse [OK].



- 3 Utilice los siguientes botones para controlar la reproducción.

[⏮]	Permite retroceder.
[OK]	Permite pausar o reanudar la reproducción.
[⏭]	Permite avanzar.
[Zoom] hacia arriba o hacia abajo	Permite ajustar el nivel de volumen.

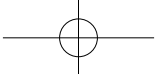

Transferencia de archivos a un ordenador (para Windows)

- 1 Inserte el CD de instalación en la unidad de CD-ROM y siga las instrucciones que aparezcan en la pantalla.
- 2 Conecte la cámara a su PC con el cable USB.

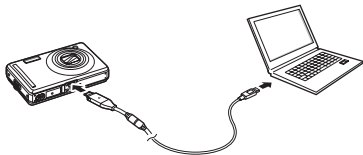

- 3 Encienda la cámara.
- 4 En el ordenador, seleccione **Mi PC** → **Disco extraíble** → **DCIM** → **100PHOTO**.
- 5 Seleccione los archivos que desee y arrástrelos o guárdelos en el ordenador.

Desconectarse de manera segura (para Windows XP)



Haga clic



Haga clic

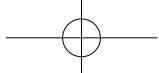

Especificaciones

Sensor de imagen	<ul style="list-style-type: none">• Tipo: 1/2,3" (aprox. 7,79 mm) CCD• Píxeles reales: aproximadamente 12,2 megapíxeles• Píxeles totales: aproximadamente 12,4 megapíxeles
Lente	<ul style="list-style-type: none">• Distancia focal: Lente Samsung $f = 5-25$ mm (equivalente en película de 35 mm: de 28 a 140 mm)• Rango de apertura del objetivo: F3,4 (W) y F5,8 (T)
Pantalla	3,0" (7,62 cm) 230 K, TFT LCD
Enfoque	Enfoque automático TTL (Multi af, Af central)
Velocidad del obturador	<ul style="list-style-type: none">• Auto: de 1/8 a 1/2.000 s• Programa de: 1 a 1/2.000 s (AEB, Continuo: de 1/4 a 1/2.000 s)• Nocturno: de 8 a 1/2.000 s• Fuegos Artificiales: 2 s
Almacenamiento	<ul style="list-style-type: none">• Memoria interna: aprox. 76 MB• Memoria externa (opcional): tarjeta SD (hasta 4 GB garantizados), tarjeta SDHC (hasta 8 GB garantizados), MMC Plus (hasta 2 GB garantizados, 4 bits, 20 MHz) <p>Es posible que la capacidad de la memoria interna no coincida con estas especificaciones.</p>
Conector de entrada de CC	34 pines
Batería recargable	Batería de litio (SLB-10A, 1.050 mAh)
Dimensiones (alto x ancho x profundidad)	95,8 x 59,5 x 23,9 mm
Peso	149 g (sin la batería ni la tarjeta de memoria)
Temperatura de funcionamiento	entre 0 y 40 °C
Humedad de funcionamiento	de 5 a 85 %

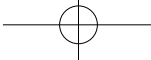

Sommaire

Informations relatives à la santé et à la sécurité	2	1
Présentation de l'appareil photo	4	12
Assemblage de votre appareil photo	5	
Contenu du coffret	5	11
Insertion de la batterie et de la carte mémoire	6	
Chargement de la batterie.....	6	
Mise en route de l'appareil	7	
Sélection des options	7	16
Prise de vues photo ou vidéo	8	25
Lecture de fichiers	9	51
Transfert de fichiers vers un PC (Windows)	10	65
Caractéristiques	11	87



Informations relatives à la santé et à la sécurité



Avertissements

N'utilisez pas l'appareil photo à proximité de gaz et de liquides inflammables ou explosifs

N'utilisez pas l'appareil à proximité de combustibles ou de produits chimiques inflammables. Ne transportez et ne stockez jamais de liquides inflammables, de gaz ou de matériaux explosifs dans le même emplacement que l'appareil ou ses accessoires.

Ne laissez pas l'appareil photo à la portée d'enfants en bas âge et d'animaux domestiques

Tenez l'appareil, ses pièces et ses accessoires, hors de portée des enfants en bas âge et des animaux. L'ingestion de petites pièces peut provoquer un étouffement ou des blessures graves. Les parties détachables et les accessoires représentent également un danger.

Evitez d'endommager la vue des sujets photographiés

N'utilisez pas le flash trop près (moins d'un mètre) des personnes et des animaux. L'utilisation du flash trop près des yeux du sujet peut provoquer des lésions temporaires ou permanentes.

FR-2

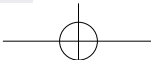

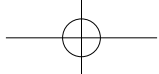

Utilisez les batteries et les chargeurs avec précaution et respectez les consignes de recyclage

- Utilisez uniquement des batteries et des chargeurs Samsung. L'utilisation de batteries et de chargeurs incompatibles peut provoquer des blessures graves ou endommager votre appareil.
- Ne posez jamais les batteries ou l'appareil à l'intérieur ou au-dessus d'un dispositif chauffant, tel qu'un four à micro-ondes, une cuisinière ou un radiateur. En cas de surchauffe, les batteries risquent d'exploser.



Attention

Manipulez et stockez votre appareil avec soins

- Évitez tout contact avec des liquides qui risqueraient d'endommager sérieusement votre appareil photo. N'utilisez pas l'appareil avec les mains mouillées. L'eau peut endommager votre appareil photo et entraîner l'annulation de la garantie du fabricant.
- Évitez d'utiliser et de stocker votre appareil dans un endroit poussiéreux, sale, humide ou mal ventilé afin de ne pas endommager ses composants internes.

- Lors du branchement des cordons et du chargeur et de l'insertion des batteries et des cartes mémoire, agissez prudemment. Enfoncer les cordons avec force ou sans précaution et insérer les batteries et les cartes mémoire de manière incorrecte peut endommager les prises et les accessoires.
- N'introduisez pas de corps étrangers dans les compartiments, les logements ou les ouvertures de l'appareil photo. Les dysfonctionnements qui s'en suivraient ne seront pas couverts par votre garantie.

Protégez les batteries, les chargeurs et les cartes mémoire

- Évitez d'exposer les batteries et les cartes mémoire à des températures extrêmes (inférieures à 0 °C / 32 °F ou supérieures à 40 °C / 104 °F). Les températures extrêmes peuvent réduire les capacités de chargement des batteries et provoquer des dysfonctionnements des cartes mémoire.
- Évitez tout contact des cartes mémoire avec des liquides, de la poussière ou des corps étrangers. Si la carte mémoire est sale, nettoyez-la avec un chiffon doux avant de l'introduire dans l'appareil photo.

FR-3

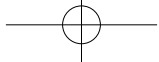

Présentation de l'appareil photo

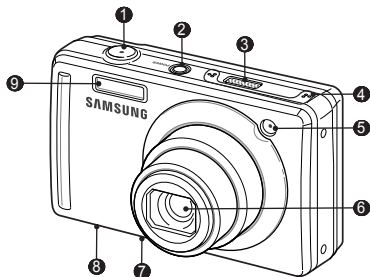

- ① Déclencheur
- ② Bouton de marche/arrêt
- ③ Haut-parleur
- ④ Microphone
- ⑤ Voyant AF / Voyant du retardateur
- ⑥ Objectif
- ⑦ Port USB, A/V et HDMI
- ⑧ Trappe batterie
- ⑨ Flash

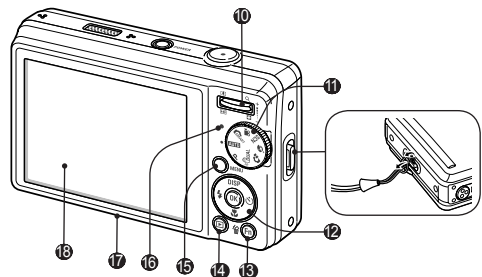

- ⑩ Touche zoom
- ⑪ Molette de réglage
- ⑫ Touche Navigation / Touche OK
- ⑬ Touche Fonction
- ⑭ Touche Lecture
- ⑮ Touche Menu
- ⑯ Voyant Indicateur
- ⑰ Fixation du pied
- ⑱ Écran

FR-4

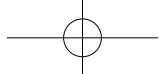

Assemblage de votre appareil photo

Contenu du coffret



Appareil photo



Adaptateur secteur /
Câble USB



Batterie rechargeable



Dragonne

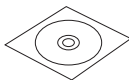

CD-ROM
(Manuel d'utilisation inclus)



Manuel de démarrage
rapide

Français

Accessoires en option



Etui de l'appareil photo



MMC



SDHC



SD

Cartes mémoire

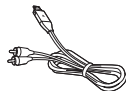

Câble audio / vidéo

Lot complet

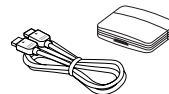

Câble HDMI / Adaptateur HDMI

FR-5

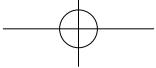

Assemblage de votre appareil photo

Insertion de la batterie et de la carte mémoire

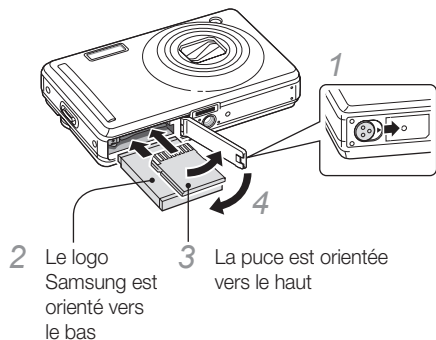

▼ Retrait de la batterie

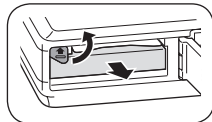

▼ Retrait de la carte mémoire

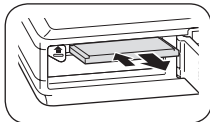

Appuyez doucement jusqu'à ce que la carte soit éjectée de sa trappe, puis retirez-la entièrement.

FR-6



Chargement de la batterie

Assurez-vous de charger la batterie avant d'utiliser l'appareil photo.

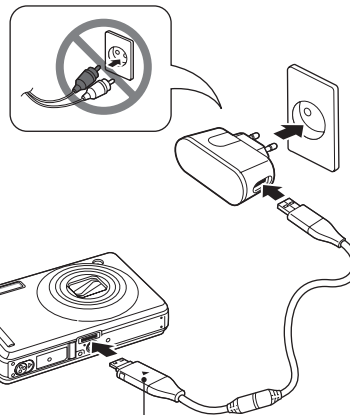

Voyant lumineux

- Rouge : en charge
- Vert : rechargé

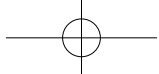

Mise en route de l'appareil

- 1 Appuyez sur [POWER].
 - L'écran d'installation s'affiche.

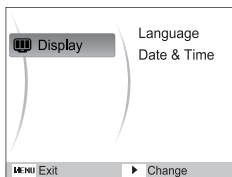

- 2 Appuyez sur [OK] pour sélectionner **Language** et appuyez sur [OK].
- 3 Appuyez sur [DISP] ou sur [OK] pour sélectionner une langue, puis appuyez sur [OK].
- 4 Appuyez sur [DISP] ou sur [OK] pour sélectionner **Date & Time**, puis appuyez sur [OK].
- 5 Appuyez sur [DISP] ou sur [OK] pour sélectionner une option.
- 6 Appuyez sur [DISP] ou sur [OK] pour changer de chiffre ou sélectionnez un autre format de date et appuyez sur [OK].

Sélection des options

- 1 En mode Prise de vue, appuyez sur [MENU].
- 2 Utilisez les touches de navigation pour atteindre une option ou un menu.

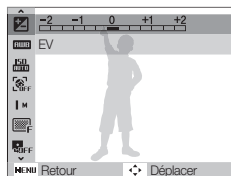

- 3 Pour vous déplacer à gauche ou à droite, appuyez sur [DISP] ou [OK].
 - Pour vous déplacer en haut ou en bas, appuyez sur [DISP] ou [OK].
- 3 Pour confirmer le menu ou l'option en surbrillance, appuyez sur [OK].
 - Appuyez de nouveau sur [MENU] pour revenir au menu précédent.

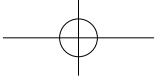

Prise de vues photo ou vidéo

Prise de vues

- 1 À l'aide de la molette de réglage, choisissez le mode **AUTO**.
- 2 Cadrez le sujet à photographier.
- 3 Appuyez à mi-course sur le déclencheur pour une mise au point automatique.
 - Un cadre vert signifie que le sujet est mis au point.

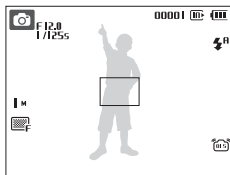

- 4 Appuyez à fond sur le déclencheur pour prendre la photo.

Filmer une séquence vidéo

- 1 À l'aide de la molette de réglage, choisissez le mode **MOV**.
- 2 Cadrez le sujet à photographier.
- 3 Appuyez sur le déclencheur.
 - Appuyez sur **[OK]** pour marquer une pause ou reprendre.
- 4 Appuyez de nouveau sur le déclencheur pour arrêter l'enregistrement.

Remarque

Nombre de photos en fonction de la résolution

(pour une carte SD de 1 Go)

	Résolution	Maximale	Élevée	Normale
12M	4000 x 3000	142	274	389
10M	3984 x 2656	162	302	426
9M	3968 x 2232	195	355	509
8M	3264 x 2448	204	361	518
5M	2592 x 1944	327	547	764
3M	2048 x 1536	511	774	1 028
2M	1920 x 1080	737	1 104	1 387
1M	1024 x 768	1 290	1 612	1 807

Ces chiffres proviennent des mesures effectuées par Samsung dans des conditions normales. Ils peuvent varier en fonction des paramètres et des conditions de prise de vue.

FR-8

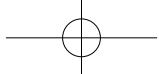

Lecture de fichiers

Visionner des photos

- 1 Appuyez sur [▶].
- 2 Appuyez sur [⚡] ou sur [⌚] pour parcourir les fichiers.
 - Maintenez votre doigt appuyé pour un défilement rapide des fichiers.

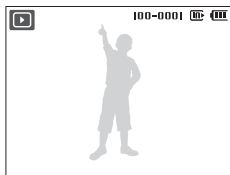

Affichage des vidéos

- 1 Appuyez sur [▶].
- 2 Appuyez sur [OK].

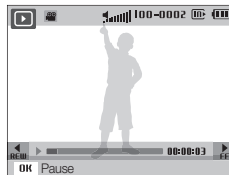

- 3 Utilisez les touches suivantes pour contrôler la lecture.

[⚡]	Retour arrière
[OK]	Mettre en pause ou reprendre après une pause
[⌚]	Avance rapide
[Zoom] vers le haut ou le bas	Réglage du niveau sonore

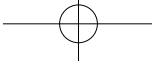

Transfert de fichiers vers un PC (Windows)

- 1 Insérez le CD d'installation dans un lecteur de CD-ROM, puis suivez les instructions qui s'affichent.
- 2 Branchez l'appareil au PC à l'aide du câble USB.

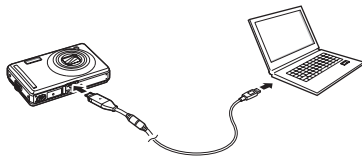

- 3 Allumez l'appareil photo.
- 4 Sur votre ordinateur, sélectionnez **Poste de travail** → **Disque amovible** → **DCIM** → **100PHOTO**.
- 5 Sélectionnez les fichiers de votre choix, puis copiez-les ou déplacez-les sur l'ordinateur.

Débranchement en toute sécurité (pour Windows XP)



Cliquez



Cliquez

FR-10

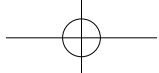

Caractéristiques

Capteur d'images	<ul style="list-style-type: none">Type : CCD 1/2.3" (environ 7,79 mm)Pixels effectifs : Environ 12,2 mégapixelsNombre total de pixels : Environ 12,4 mégapixels
Objectif	<ul style="list-style-type: none">Distance focale : Objectif Samsung f = 5 - 25 mm (équivalent à un film 35 mm : 28 - 140 mm)Plage d'ouverture de l'objectif : F3,4 (W) - F5,8 (T)
Écran	Écran LCD TFT 3.0" (7,62 cm) 230 000 pixels
Mise au point	Mise au point auto TTL (Mise au point multiple, Mise au point au centre)
Vitesse d'obturation	<ul style="list-style-type: none">Automatique : 1/8 - 1/2 000 s.Programme : 1 - 1/2 000 s. (AEB, Continue : 1/4 - 1/2 000 s.)Nuit : 8 - 1/2 000 s.Feux d'artifice : 2 s.
Stockage	<ul style="list-style-type: none">Mémoire interne : Environ 76 MoMémoire externe (en option) : Carte SD (jusqu'à 4 Go garanti), carte SDHC (jusqu'à 8 Go garanti), MMC Plus (jusqu'à 2 Go garanti, 4 bits 20 MHz) <p>La capacité de la mémoire interne peut varier par rapport à ces caractéristiques.</p>
Connecteur d'alimentation CC	34 broches
Batterie rechargeable	Batterie lithium-ion (SLB-10A, 1 050 mAh)
Dimensions (l x h x p)	95,8 x 59,5 x 23,9 mm
Poids	149 g (sans la batterie ni la carte mémoire)
Température de fonctionnement	0 - 40 °C
Humidité de fonctionnement	5 - 85 %

FR-11

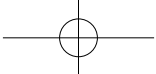

Please refer to the warranty that came with your product or visit our website <http://www.samsungcamera.com/> for after-sales service or inquiries.

Pour toute question ou demande de service après-vente, veuillez consulter les conditions de garantie qui accompagnent le produit ou visitez notre site Internet <http://www.samsungcamera.com/>.



AD68-04168A (1.1)